

ALTERNATOR

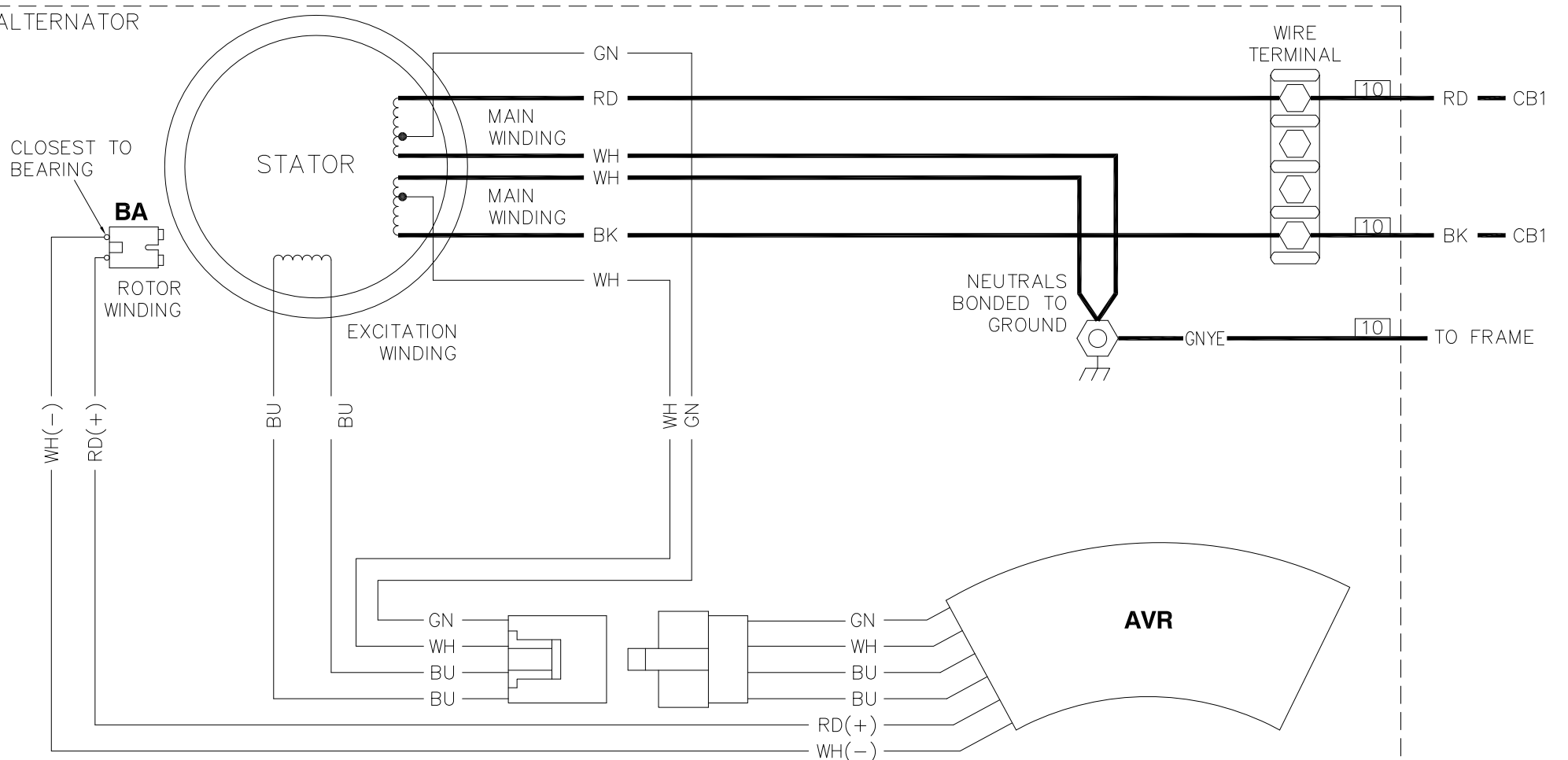

ENGINE BLOCK

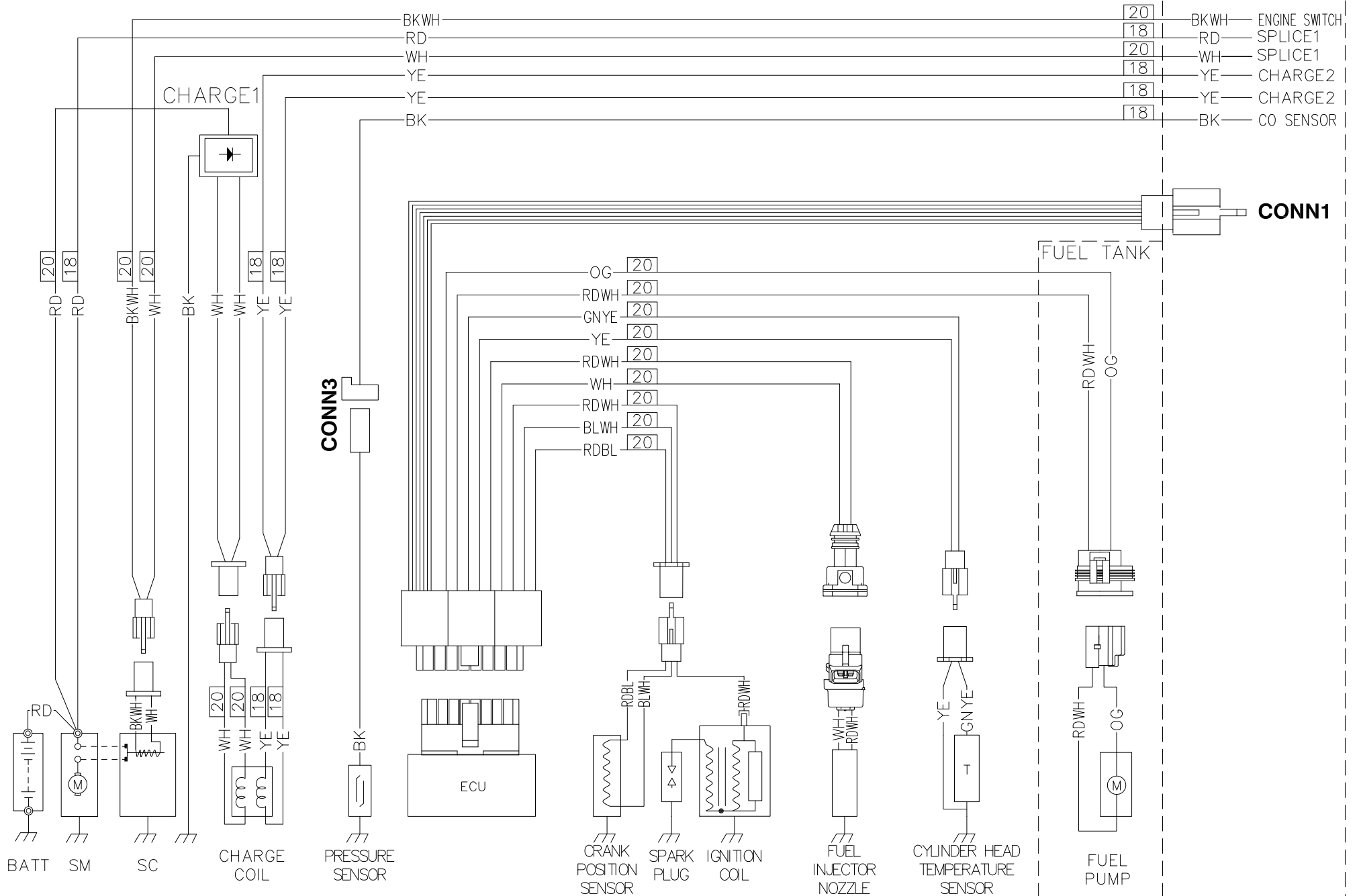

CONTROL PANEL BLOCK

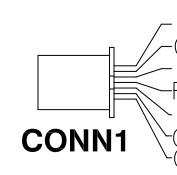
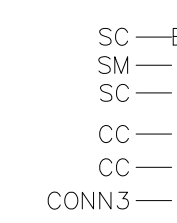
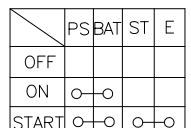
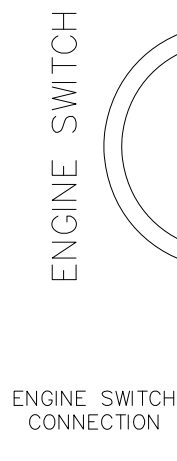
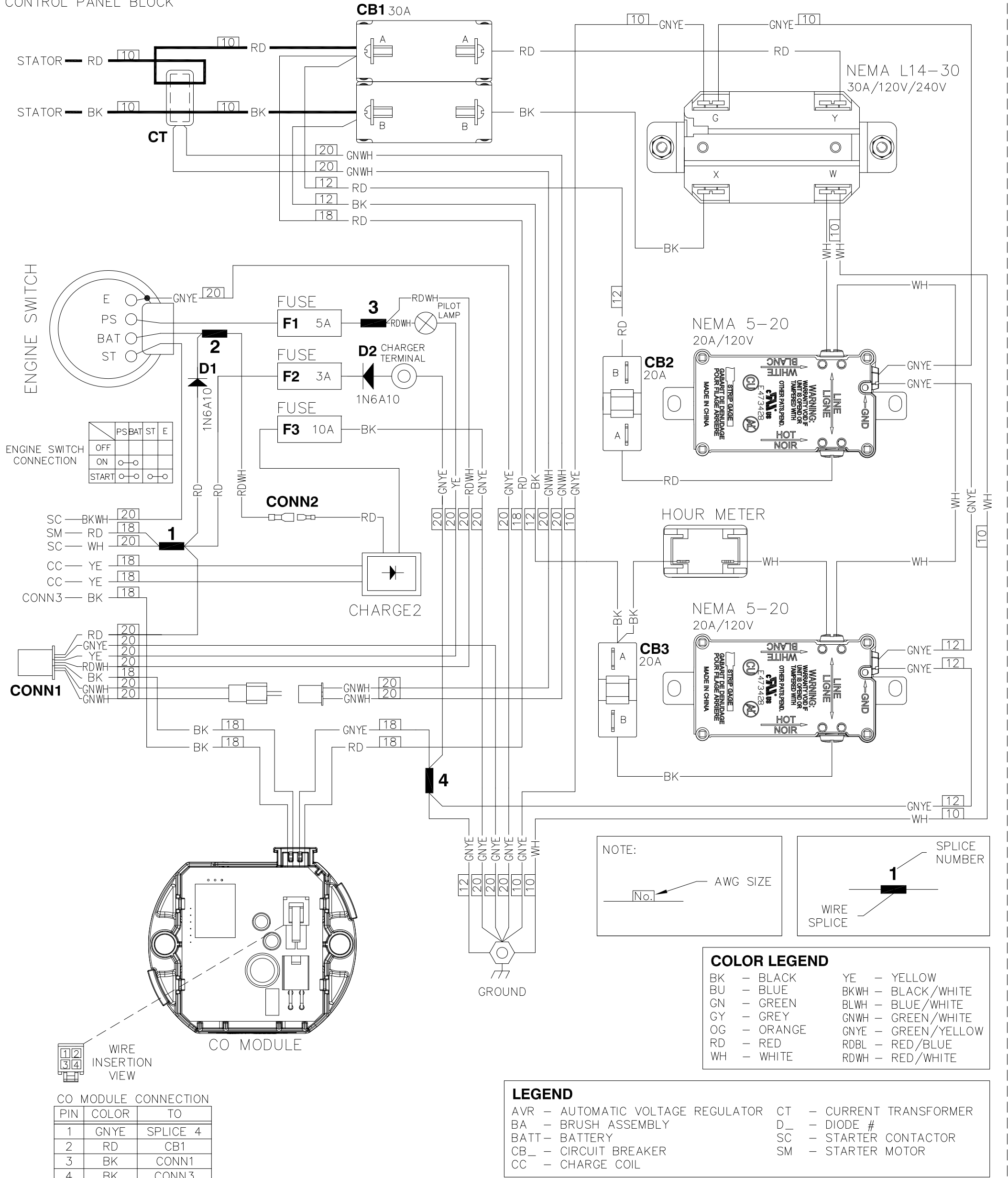

CO MODULE CONNECTION

PIN	COLOR	TO
1	GNYE	SPLICE 4
2	RD	CB1
3	BK	CONN1
4	BK	CONN3

NOTE:

No. — AWG SIZE

SPLICE NUMBER

1 — WIRE SPLICE

COLOR LEGEND

BK — BLACK	YE — YELLOW
BU — BLUE	BKWH — BLACK/WHITE
GN — GREEN	BLWH — BLUE/WHITE
GY — GREY	GNWH — GREEN/WHITE
OG — ORANGE	GNYE — GREEN/YELLOW
RD — RED	RDBL — RED/BLUE
WH — WHITE	RDWH — RED/WHITE

LEGEND

AVR — AUTOMATIC VOLTAGE REGULATOR	CT — CURRENT TRANSFORMER
BA — BRUSH ASSEMBLY	D_ — DIODE #
BATT — BATTERY	SC — STARTER CONTACTOR
CB_ — CIRCUIT BREAKER	SM — STARTER MOTOR
CC — CHARGE COIL	